

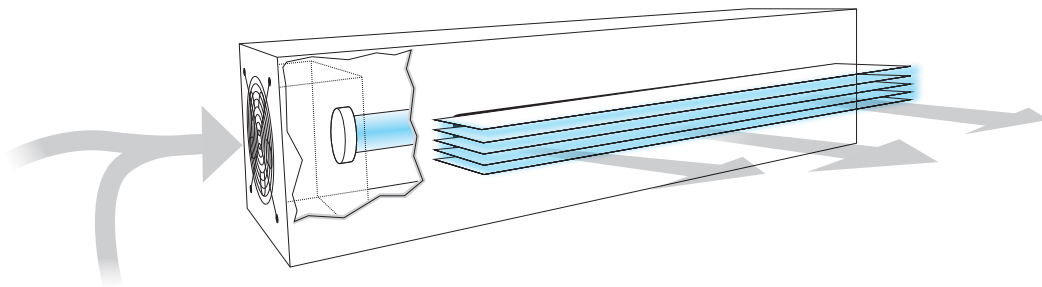

Better Air | Better Water | Better Living™

# OWNER'S GUIDE

## Upper Room UV-C Air Disinfection



### Models

#### FS-22F

Wall mount system, 22-inch UV lamp

#### FS-33F

Wall mount system, 33-inch UV lamp

#### FS-22F-CR

Ceiling mount system, 22-inch UV lamp

#### FS-33F-CR

Ceiling mount system, 33-inch UV lamp

Read and follow all safety instructions.

Save this manual for reference. Space is provided for recording annual UV lamp changes.

[www.ultravation.com](http://www.ultravation.com)



# Upper Room UV-C Air Disinfection

## General Information, Maintenance and Safety

**Minimum mounting height is 7 feet from floor.**  
**Never look directly at the ultraviolet lamps while in operation.**

### Package contents:

1 Upper room air sanitizer system  
1 UV-C germicidal UV lamp  
3 Wire nuts  
1 Warranty card, UV warning label

### Maintenance:

Maintenance of the sanitizer includes replacement of the UV-C lamp every 9,000 hours – approximately 1 year. This is important as UV lamps undergo a photochemical process during operation. This slowly reduces the amount of UV light generated to disinfect against airborne pathogens. When changing lamps, unit should be inspected for accumulated dust on reflectors.

**Important:** We recommend lamp replacement with genuine Ultravation replacement lamps. Ultravation lamps are specifically designed not to produce ozone. Some third party lamps available may produce various levels of ozone. Ozone is not recommended for occupied spaces. For more information please visit:

<https://www.epa.gov/indoor-air-quality-iaq/ozone-generators-are-sold-air-cleaners>

When installing new lamps, ensure that the lamp glass is free of any fingerprints or debris, as this may alter the path of the UV energy. Use rubbing alcohol and a dry cloth to remove any surface contaminants.

### Replacement Lamp Part Numbers:

22" Germicidal lamp non ozone: **AS-IH-1015** 33" Germicidal lamp non ozone: **AS-IH-0614**

### Safety Precautions:

It is recommended that this unit be installed and maintained by a trained technician.



**WARNING:** UV Hazard. Always protect eyes from ultraviolet light. NEVER look at UV lamps in operation. **Turn off power before re-lamping or servicing.**



**WARNING:** UV light can cause severe eye damage or temporary blindness.



**WARNING:** DO NOT install sanitizer with bottom of unit lower than 7 feet from the floor.



This symbol indicates potential hazards with this product that can result in property damage and/or serious injury or death

**Attention:** be sure that no objects are within 6 feet of direct line of site from the front of the sanitizer. Color shift or structural degradation may occur.

**Note:** In the event of accidental breakage or replacement of the ultraviolet lamp, ensure that the lamp is disposed of in accordance with local environmental laws regarding fluorescent lamps containing mercury.

All specifications, dimensional data, and appearance are subject to change without notice.

# Upper Room UV-C Air Disinfection Installation

## Installation instructions for FS-22F-CR and FS-33F-CR:

**Electrical:** This product can be hardwired into an electrical circuit or powered via the provided 6 ft. power cord. For a hardwired connection, or if you are not comfortable with installing the power cord, it is recommended that a licensed electrician perform this task following all national and local electrical codes.

**Mounting:** The sanitizer has two mounting connections on the top for 3/4" or 1" conduit. Note: there are also two key slots to attach a safety chain (chain not supplied). Mounting holes are 32-1/4" on center (FS-33F-CR) and 20.25" on center (FS-22F-CR). Product weight is 30 lbs (FS-33F-CR) and 28 lbs (FS-22F-CR).

**1:** Remove front and rear grill plates using a #2 Phillips screw driver. For protection in transit, note that the grills ship with protruding fins facing inward. These must be reversed and positioned on the outside when placed back on the unit. With the grills off, carefully remove the UV lamp and any protective material. Caution must be taken as lamps are fragile. Discard any packaging.

**2:** Set the power switch to the off position. Install power cord if applicable. Do not plug in at this time.

**3:** Securely fasten the unit in its desired location. **MUST** be level. Gently slide the top reflector pieces to the right or left to gain access to the mounting holes. Install safety chain to meet code requirements if needed (chain not included).

**4: Important: Ensure that A) the unit is unplugged or B) the power is turned off to the hardwire connection point at this time.** Wire properly per local and state code as is applicable. Re-install lamp. If hardwired, it is recommended that this product be installed with a separate, dedicated on/off switch.

**5:** Re-install cover plates with the fins facing outwards. Restore power. The unit can be turned on.

**⚠ Do not look directly at the UV-C lamp.**

**⚠ Important: Do not install lower than 7 feet! Danger of exposure to germicidal UV-C light may occur.**

**⚠ The mounting surface must be able to safely support 30 lbs.**

**⚠ Horizontal mounting only, do not mount this product vertically as unintended exposure to UV-C energy is possible.**

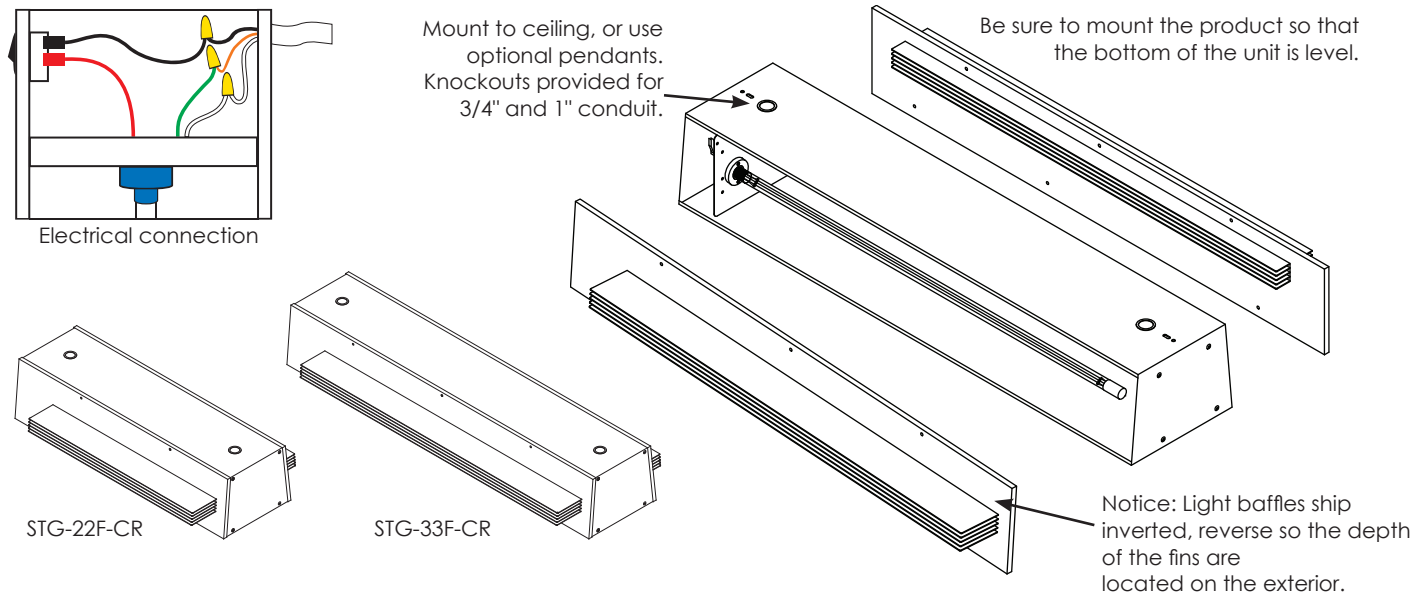

## Specifications

	Average sq. ft.	Total UV-C output	UV lamp wavelength	UV lamp life	Power consumption	Width	Height	Depth
BioGardUV™ FS-22F	225 (15'x15')	10w	254nm	9,000 hrs	36.5VA	26.1"	6.1"	9.2"
						66.29cm	15.49cm	23.37cm
BioGardUV™ FS-33F	350 (16'x22')	16w	254nm	9,000 hrs	44.5VA	37.7"	6.1"	9.2"
						95.76cm	15.49cm	23.37cm
BioGardUV™ FS-22F-CR	450 (15'x30')	10w	254nm	9,000 hrs	36.5VA	26.1"	6.1"	13.5"
						66.29cm	15.49cm	34.29cm
BioGardUV™ FS-33F-CR	700 (16'x44')	16w	254nm	9,000 hrs	44.5VA	37.7"	6.1"	13.5"
						95.76cm	15.49cm	34.29cm

**Power:** All models auto-sensing 120-277 VAC, 50/60 hz.

**Important: When installed, bottom of fixture must be at least 7 feet above the floor.**

# Upper Room UV-C Air Disinfection

## Principle of Operation

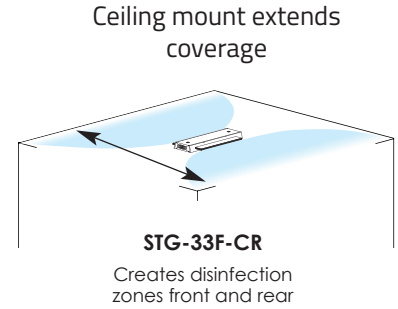
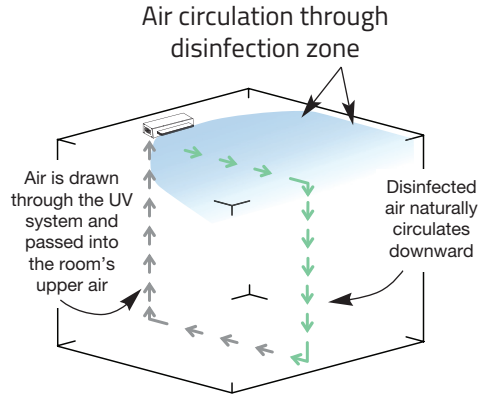
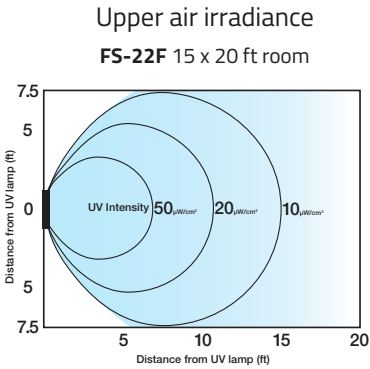

## Placement

Typical placement for various models

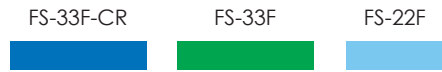

Contact Ultravation for specific room layout questions

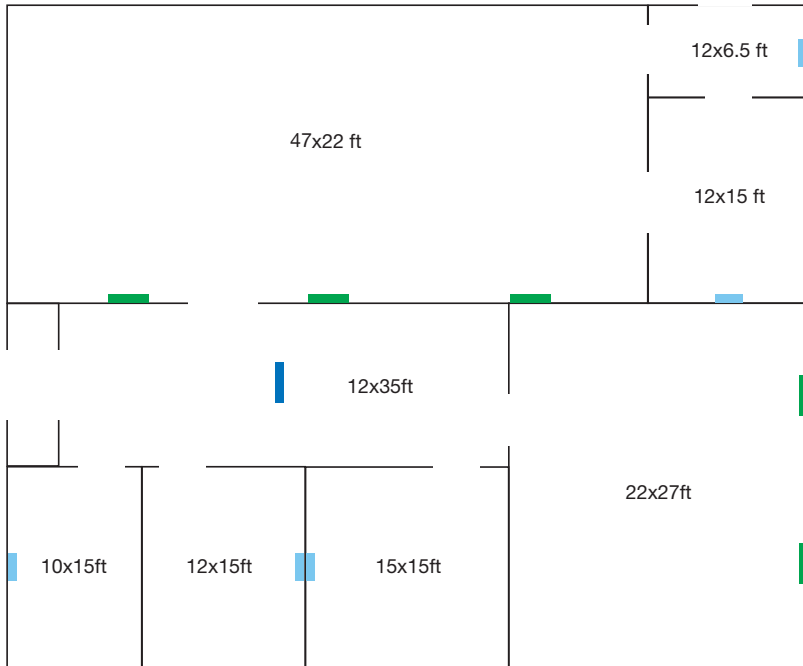

## Warranty:

Ultravation Upper Room Disinfection equipment are protected by a five-year warranty from the factory after date of consumer purchase.

This warranty does not include damage to the unit from accident, misuse or improper installation.

If this product should become defective, Ultravation will elect to repair or replace the product free of charge. Ultravation will return repaired or replaced warranted products pre-paid to the customer, provided that the product was delivered pre-paid.

Ultravation shall have no responsibilities for charges incurred by the customer for installation or removal of warranted items. Liability is limited only to the replacement or repair of this product.

This warranty gives you specific legal rights, and you may also have other rights, which vary from state to state. All returns must be accompanied by a return authorization number, which may be obtained by contacting Ultravation.