

INSTALLATION INSTRUCTIONS



K302PE

ClearTouch™



Specifications:

Power Supply: 120VAC/240VAC 50/60Hz

Max Range: 1800W @120V or 3600 W @ 240 V

Max Range: 15A Max, Resistive

Accuracy: ±01F (01C)

Temperature Control Range: 41°F-95°F

Temperature Adjustment Scale: 1°F

Listing: c ETL us 

! DANGER !

ELECTRIC SHOCK OR FIRE HAZARD

READ ALL WIRE SIZING, VOLTAGE REQUIREMENTS AND SAFETY DATA TO AVOID PROPERTY DAMAGE AND PERSONAL INJURY

! WARNING !

READ CAREFULLY - These instructions will help prevent difficulties that might arise during thermostat installation. Studying the instructions first may save considerable time and money later. Observing the following procedures will keep installation time to a minimum. Save these instructions for future use.

FUNCTIONS AND FEATURES

This Thermostat has been designed to control fan-forced and radiant line voltage electric heater.

- Dual Voltage (120vac or 240vac)
- 7 day programmable settings
- Touch-Sensitive Buttons
- Blue Backlit Display
- Temperature Lock Feature: Set a Min and Max Temp Limit
- System On/Standby switch

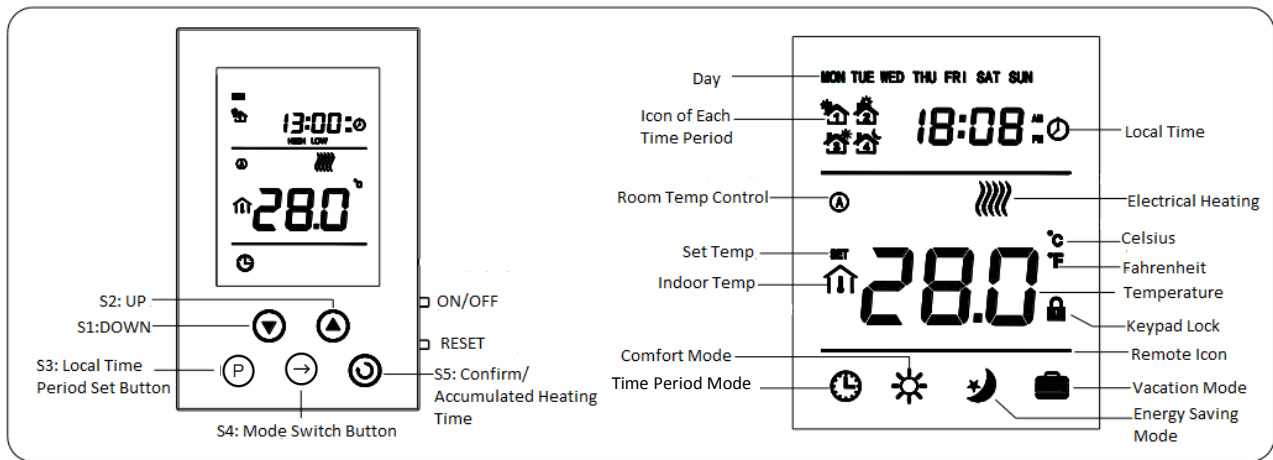
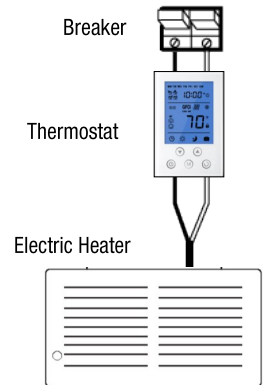

PRODUCT OVERVIEW

The ClearTouch K302PE combines user-friendly touch sensitive buttons with a sleek modern design, offering unparalleled user control. It's highly accurate sensing technology saves up to 28% on heating costs. Energy-Saving Programmable Solution For Providing Highly Accurate Temperature Control For Line Voltage Electric Heaters. It is accurate and sensitive with high reliability and high performance. Program a full 7 day schedule with ease for total room control.

INSTALLATION INSTRUCTIONS

DANGER

ELECTRIC SHOCK OR FIRE HAZARD

READ ALL WIRE SIZING, VOLTAGE REQUIREMENTS AND SAFETY DATA TO AVOID PROPERTY DAMAGE AND PERSONAL INJURY

The installation of the thermostat must comply with the applicable local and/or national electrical code and utility requirements. This installation should be performed by a qualified electrician where required by law. Ensure that all wiring connections to the thermostat are correct and tight to prevent electrical shorts. Use the appropriate wire to meet local and national electrical codes for rated power consumption.

WARNING!

Warning: Turn OFF the power at the circuit breaker before installing. Installation to be performed by a qualified electrician or authorized technician.

Refer to thermostat and heater load specifications before installation of the thermostat to see if it can handle the amp load. The maximum this thermostat can run is 1800W @120V or 3600 W @ 240 V (15A). Install unit in a grounded metal or plastic wall junction box, indoors 4 1/2' to 5' above the floor. Avoid any area where it can come in contact with external sources of heat and cold. This includes plumbing pipes, direct sunlight, a T.V. set, lamps, and drafts from a door or window, as this may cause inaccurate temperature readings. The most convenient place is above the light switch. Not for Outdoor use.

WIRING INSTRUCTIONS

Caution: Turn off power at the circuit breaker before performing any work on the electrical connections. None of the electrical connections must be live until the installation has been completed and the housing is closed. Only a qualified electrician or authorized technician are permitted to open the terminal box.

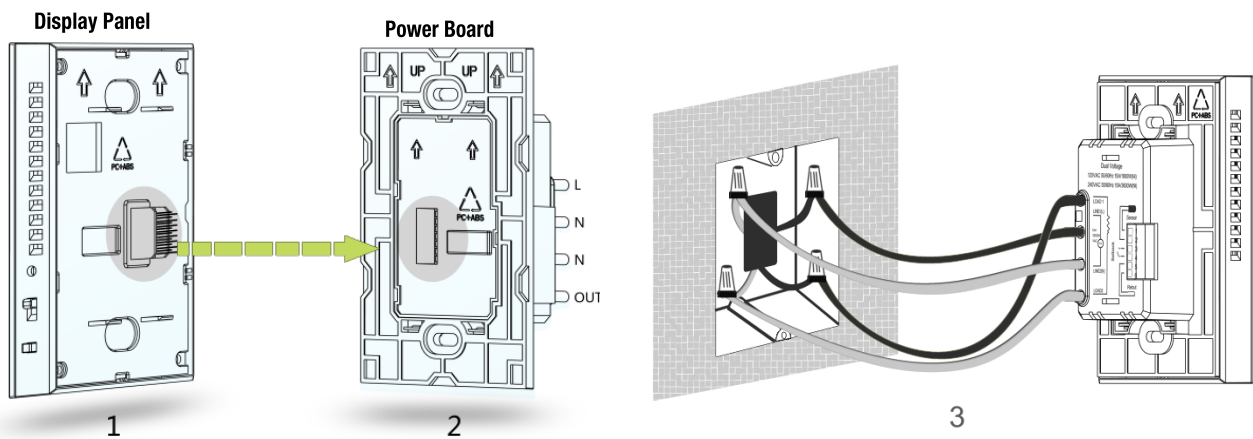

Wiring requires a Phillips screwdriver

1. Disconnect power supply to prevent electrical shock or damage to the product.
2. Run line voltage wiring to the location of thermostat.
3. Use a screwdriver to separate the Display Panel and power board of the thermostat, as shown in Figure 1 and Figure 2
4. Choose the proper installation location. Installation height is about 4 1/2 to 5 feet above the floor. For indoor use only.
5. Do not install close to a heat source, such as hot water pipe, heating pipe, wall-mounted light fixture or in direct sunlight.
6. Connect the incoming power wires to Line 1(L) & Line 2(N) wires on the power board, using the provided wire nuts, as shown on figure 3.
7. Connect the heater load wires to the Load 1 & Load 2 wires of the power board, using the connectors, as shown on figure 3.

(Optional) Connection to a Slave Relay (K312RELAY)

If the heating area requires the addition of a Slave Relay, connect the low voltage wire for an auxiliary Slave Relay (K312RELAY) into terminals 5 & 6 (Relout) on back of the power board to add a zone. See drawing below.

9. Install the power board into the electrical box with the 2 screws provided, and then clip & fasten the front Display Panel into place with the bottom screw.
10. Make sure your K302PE thermostat is COMPLETELY RECESSED into the junction box and flush with the wall. NO WIRES SHOULD BE EXPOSED outside the metal or plastic junction box.

WIRING INSTRUCTIONS (CONTINUED)

WIRING DIAGRAM:

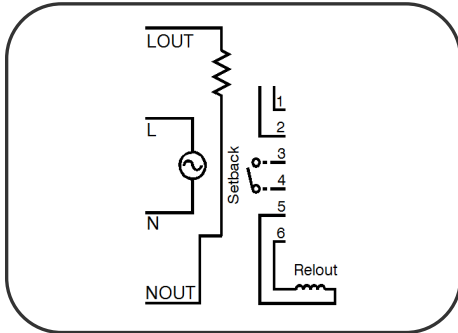

Safety Information:

- Installation must be carried out by a certified professional electrician.
- Disconnect all power before performing maintenance work to avoid product damage.
- Shocking, dropping or stepping on the product will damage it and void the warranty.
- The thermostat should be kept away from corrosive chemicals.
- Damage to the product could result in a faulty electrical system that may cause fire.

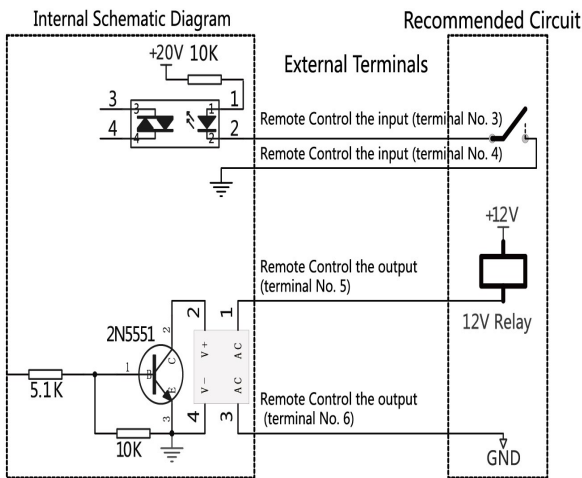

Control Wiring :

- **Setback:** This is an **input** signal driven by a remote contact. One terminal connects to the internal power source by 10K resistance; another terminal connects to the internal ground. The circuit diagram as shown on the left.
- **Relout:** This is an **output** allowing the remote control of a series of Slave Relays (K312RELAY). Inside the thermostat is an open drain circuit, driving a 24V relay. The maximum drive current is 30mA. The circuit diagram as shown in the left. This is used to connect to a Slave Relay (K312RELAY) to expand the heating surface. Multiple Slave Relays can be interconnected in a daisy chain, see below:

Master / Slave Wiring Diagram

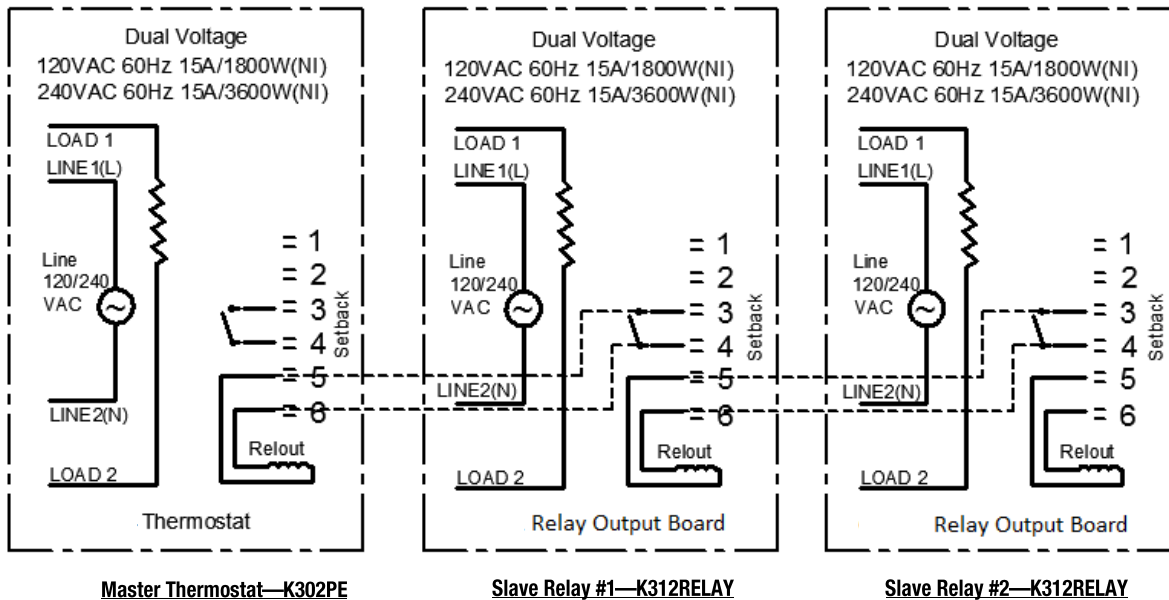

Master Thermostat—K302PE

Slave Relay #1—K312RELAY

Slave Relay #2—K312RELAY

OPERATION INSTRUCTIONS



K302PE
ClearTouch™

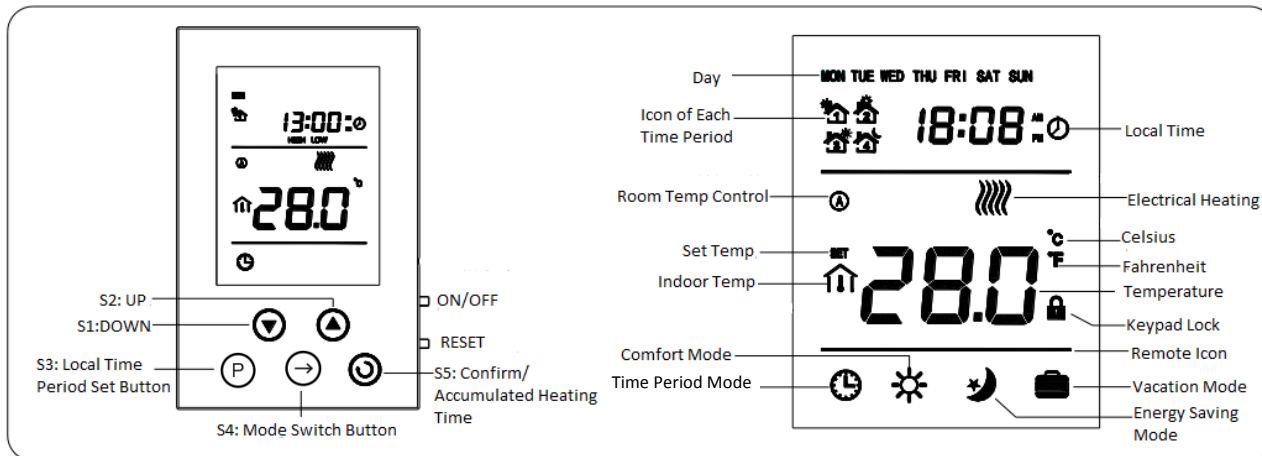

ON/OFF Settings

ON: From the OFF status, slide the ON/OFF side switch up to turn the unit on. Time clock, actual probe temperature, working mode and output status will be displayed on the screen.

OFF: From the ON status, slide the ON/OFF switch down to turn the unit off. It will display OFF and all outputs will be open.

Reset

Under OFF mode, press reset button 3sec, then the thermostat will return to factory default. The factory default temperature unit is Fahrenheit and the default time system is 12Hours.

Setting the Time

In the normal working interface, press button for 3sec. to enter into the Time setting interface.

First, "WEEK" is blinking, press or button to set the day of the week;



When finished setting the DAY, press button to switch to HOUR, "HOUR" is blinking, press or button to set the hour;

When finished setting the HOUR, press button to switch to MINUTE, "MINUTE" is blinking, press or button to set the minutes.

When finished setting the MINUTE, press button or wait for 10 sec. without any operation to save the new values and return to the normal interface automatically.

OPERATION INSTRUCTIONS CONT.

Setting the Control Mode

In the normal control interface, press  button to enter into the Control Mode settings interface. The control mode will be changed for every press of  button. Press  button continuously, then all the working modes will cycle.

When the icon  displays on the screen indicates it's in Time Period Mode ;

When the icon  displays on the screen indicates it's in Comfort Mode ;

When the icon  displays on the screen indicates it's in Energy-saving Mode ;

When the icon  displays on the screen indicates it's in Vacation Mode ;

When the corresponding icon of working mode is blinking, press  button to confirm or wait for 10sec. without any operation to save the values and return to the normal working interface automatically.

Setting the Set Temp

In any mode, press  or  button to enter into the Set Temp settings interface of the corresponding mode. The Set Temp is blinking.





Press  button to decrease the temperature, press  button to increase the temperature set point.

After enter into the interface of Set Temp settings, press  or  button for 3 sec. to decrease/ increase the temperature continuously.

Once completed, press  button to confirm changes or wait for 10s without any operation to save the values and return to the normal working interface automatically.

Keypad Lock

In the normal working interface, press  and  buttons simultaneously to lock the keypad, at the same time the icon  will display on the screen.



When the keypad is locked, no adjustment is possible. When the icon of Keypad Lock  displays on the screen, press  and  buttons simultaneously to unlock the keypad, and the icon  will disappear from the screen and the keypad is back to its normal state.

Setting the Time Periods (Schedule)

In the normal working interface, press  button to enter into the Time Period settings interface. First, the "HOUR" of the first period is blinking.

The blinking item is adjustable, press  or  button to change the value.

In the setting interface, press  button to switch the weekday, the sequence is Monday - Tuesday - Wednesday -Thursday- Friday - Saturday - Sunday - Exit.

In the setting interface, press  button to switch the following parameters: HOUR, MINUTE, Set Temp, and Time Period of each day, press  button continuously, the time period will be switched from the 1st period to the 4th period.

In the setting interface, press  button to return to the normal working interface directly, and the new values will be saved.

OPERATION INSTRUCTIONS CONT.





The default values of time periods are as follow :

7 Days	Default Values of the Time Periods			
Time Period	1	2	3	4
Start Time	5:00	7:00	5:00	10:00
Set Temp	20°C (68°F)	18°C (64°F)	20°C (68°F)	18°C (64°F)



Note: The default start time of the second period of Saturday and Sunday is different from the default start time of Monday to Friday. The default start time of the second period of Saturday and Sunday is 9 : 00, but the Set Temp is the same.

Output Control

Room Temperature Control Mode

When the icon  displays on the screen it indicates the system is in Room Temperature Control Mode, when the icon  displays on the screen, indicating the ambient temperature from the built-in probe. When the detected indoor temperature is below the set temperature by -2°C (-4°F), electrical heating will be turned on, and the icon  will display on the screen; when the detected indoor temperature is above the set temperature, electrical heating will be turned off, and the icon  will disappear from the screen.



Remote Control of Thermostat

When there is a remote control signal input, the Remote icon (bar) blinks; when the detected indoor temperature is below the set temperature by -2°C (-4°F), electrical heating will be turned on, and the icon  will display on the screen; meanwhile, the Relout sends the output signals. When the detected indoor temperature is above the set temperature, electrical heating will be turned off, and the icon  will disappear, and the Relout turns off the power module output signal. The default set temperature is 16.5°C (61°F) on the remote control mode. Note: Remote signal control signal has the highest priority in the logic sequence.

Sensor Failure



When the sensor fails to work, the error icon EEE will be displayed on the screen. The output relay will open. Heating output will stop. Replace sensor.

Cumulative Heating Time to compute energy consumption

Press  button, the cumulative heating time will be displayed on the screen. The cumulative time will reset and restart when press  and  buttons simultaneously. (Unit : min)

OPERATION INSTRUCTIONS CONT.

Configuration of User Parameters (Hidden Menu)

When the thermostat is OFF: Press  and  buttons simultaneously to enter into the setting interface. Default values and options are defined below:

NO.	Parameter	Default Value	Setting Range	Note
P1	Room Temperature Calibration	0 (00)	-9~9°C (-9~9°F)	
P2	Temperature Backlash Value	2°C (04°F)	0.5~10°C (1-18°F)	
P3	Key Volume Level	3	0F/0~9	0F: OFF 0~9: Length of the Key Volume
P4	Backlight Brightness	5	1~8/ON/ 0F	1~8: Reserved ON: Always on 0F: Energy Saving of Backlight
P5	Remote control mode temperature setting	16.5°C (62°F)	05~21°C (41-70°F)	
P6	Energy saving mode temperature setting	16.5°C (62°F)	05~21°C (41-70°F)	
P7	Away mode temperature setting	10°C (50°F)	05~21°C (41-70°F)	
P8	Celsius/Fahrenheit	0F	0C/0F	0C:Celsius 0F:Fahrenheit (After setting, please reset to factory default.)
P9	Time System	12	12/24	12: 12Hours 24: 24Hours
P10	Max. Temp. range	30°C (85°F)	4-35°C (40-95°F)	
P11	Min. Temp. range	4°C (40°F)	4-35°C (40-95°F)	
P12	Heating temp increasing speed	5	0~99	
P13	Factory Reset	53	0~99	Set it to 55 and then press S3 to confirm to set it to Factory Reset.

Troubleshooting

Problem	Solution
Thermostat functions but no heat from the system	Check wiring instructions & wire identification. Refer to heater manufacturer's installation manual.
No display	Check wiring connection on the back of the unit
Heat occurs at wrong time	Check the current time and schedule are properly set at AM or PM
Error EEE	Build-in air-sensor is defective. Contact supplier for replacement.